

Genome-wide analysis of nearly all the victims of a 6200 year old massacre

Novak, Mario; Olalde, Iñigo; Ringbauer, Harald; Rohland, Nadin; Ahern, James; Balen, Jacqueline; Janković, Ivor; Potrebica, Hrvoje; Pinhasi, Ron; Reich, David

Source / Izvornik: **PLOS ONE, 2021, 16**

Journal article, Published version

Rad u časopisu, Objavljena verzija rada (izdavačev PDF)

<https://doi.org/10.1371/journal.pone.0247332>

Permanent link / Trajna poveznica: <https://urn.nsk.hr/urn:nbn:hr:131:622759>

Rights / Prava: [Attribution 4.0 International](#)/[Imenovanje 4.0 međunarodna](#)

Download date / Datum preuzimanja: **2024-07-04**



Sveučilište u Zagrebu
Filozofski fakultet
University of Zagreb
Faculty of Humanities
and Social Sciences

Repository / Repozitorij:

[ODRAZ - open repository of the University of Zagreb
Faculty of Humanities and Social Sciences](#)



RESEARCH ARTICLE

Genome-wide analysis of nearly all the victims of a 6200 year old massacre

Mario Novak¹*, Iñigo Olalde^{2,3}*, Harald Ringbauer^{3,4}*, Nadin Rohland^{3,5}, James Ahern⁶, Jacqueline Balen⁷, Ivor Janković^{1,6}, Hrvoje Potrebica⁸, Ron Pinhasi^{9,10}‡*, David Reich^{3,4,5,9,10}‡*

1 Centre for Applied Bioanthropology, Institute for Anthropological Research, Zagreb, Croatia, **2** Institute of Evolutionary Biology, CSIC - Universitat Pompeu Fabra, Barcelona, Spain, **3** Department of Genetics, Harvard Medical School, Boston, Massachusetts, United States of America, **4** Department of Human Evolutionary Biology, Harvard University, Cambridge, Massachusetts, United States of America, **5** Broad Institute of Harvard and MIT, Cambridge, Massachusetts, United States of America, **6** Department of Anthropology, University of Wyoming, Laramie, Wyoming, United States of America, **7** Archaeological Museum in Zagreb, Zagreb, Croatia, **8** Faculty of Humanities and Social Sciences, University of Zagreb, Zagreb, Croatia, **9** Department of Evolutionary Anthropology, University of Vienna, Vienna, Austria, **10** Howard Hughes Medical Institute, Harvard Medical School, Boston, Massachusetts, United States of America

* These authors contributed equally to this work.

‡ Denotes co-senior authors.

* mario.novak@inantro.hr (MN); ron.pinhasi@univie.ac.at (RP); reich@genetics.med.harvard.edu (DR)



OPEN ACCESS

Citation: Novak M, Olalde I, Ringbauer H, Rohland N, Ahern J, Balen J, et al. (2021) Genome-wide analysis of nearly all the victims of a 6200 year old massacre. PLoS ONE 16(3): e0247332. <https://doi.org/10.1371/journal.pone.0247332>

Editor: Peter F. Biehl, University at Buffalo - The State University of New York, UNITED STATES

Received: November 9, 2020

Accepted: February 4, 2021

Published: March 10, 2021

Copyright: © 2021 Novak et al. This is an open access article distributed under the terms of the [Creative Commons Attribution License](https://creativecommons.org/licenses/by/4.0/), which permits unrestricted use, distribution, and reproduction in any medium, provided the original author and source are credited.

Data Availability Statement: The datasets generated and/or analyzed during the current study are included in this article (and in the [Supporting information](#)). The genotypes have been deposited for public access to the Reich lab website (<https://reich.hms.harvard.edu/datasets>) and the aligned sequences to the EMBL Nucleotide Sequence Database (ENA) with the accession number PRJEB42243.

Funding: M.N., I.J. and J.B. were supported by the Croatian Science Fund grant HRZZ IP-2016-06-1450. I.O. was supported by a fellowship from "Ia

Abstract

Paleogenomic and bioanthropological studies of ancient massacres have highlighted sites where the victims were male and plausibly died all in battle, or were executed members of the same family as might be expected from a killing intentionally directed at subsets of a community, or where the massacred individuals were plausibly members of a migrant community in conflict with previously established groups, or where there was evidence that the killing was part of a religious ritual. Here we provide evidence of killing on a massive scale in prehistory that was not directed to a specific family, based on genome-wide ancient DNA for 38 of the 41 documented victims of a 6,200 year old massacre in Potočani, Croatia and combining our results with bioanthropological data. We highlight three results: (i) the majority of individuals were unrelated and instead were a sample of what was clearly a large farming population, (ii) the ancestry of the individuals was homogenous which makes it unlikely that the massacre was linked to the arrival of new genetic ancestry, and (iii) there were approximately equal numbers of males and females. Combined with the bioanthropological evidence that the victims were of a wide range of ages, these results show that large-scale indiscriminate killing is a horror that is not just a feature of the modern and historic periods, but was also a significant process in pre-state societies.

Introduction

Violence on a massive scale has been present in human societies for at least 13,000 years as evidenced by numerous skeletons of both sexes and all ages showing fatal violent injuries from

Caixa" Foundation (ID 100010434), code LCF/BQ/PI19/11690004. D.R. was supported by the National Institutes of Health (NIGMS GM100233), the John Templeton Foundation (grant 61220), and the Paul Allen Foundation (Allen Discovery Center grant), and is an Investigator of the Howard Hughes Medical Institute. The ancient DNA work was funded by NIH (NIGMS) grant GM100233, the Paul Allen Foundation, the John Templeton Foundation grant 61220 and the Howard Hughes Medical Institute. The funders had no role in study design, data collection and analysis, decision to publish, or preparation of the manuscript.

Competing interests: I have read the journal's policy and the authors of this manuscript have the following competing interests: Mario Novak and Ron Pinhasi serve as Academic Editors for PLOS ONE.

the cemetery of Jebel Sahaba in Sudan [1–3] which is generally regarded as representing the earliest evidence of collective violence or warfare [4]. This hypothesis was additionally strengthened by the recent publication of the massacre of a group of prehistoric hunter-gatherers near Lake Turkana in Kenya [5], although some doubt the conclusion that this site represents early intragroup violence [6]. In Europe, beside the Early Neolithic Linearbandkeramik (LBK) massacre sites of Talheim [7] and Asparn/Schletz [8], several similar examples dated to prehistoric periods have been recorded [9–13]. Paleogenomic and bioanthropological studies of ancient massacres have highlighted sites where the victims were male and plausibly died all in battle [14], or were executed members of the same family as might be expected from a killing intentionally directed at subsets of a community [13], or where the massacred individuals were plausibly members of a migrant community in conflict with previously established groups [9], or where there was evidence that the killing was part of a religious ritual [15].

When dealing with such events in both ancient and modern contexts, we need a clear definition of the term “massacre”. Various definitions are used [16–20], and here we use the one proposed by Alfsdotter and colleagues [21] in their study of the massacre at Sandby borg: “an act of intentional murder upon a mass of people who were not prepared for battle, with the killing being conducted by a group”.

We provide evidence of killing on a massive scale that was not directed to a specific family by generating genome-wide ancient DNA for 38 of the 41 documented massacre victims retrieved from the Eneolithic mass burial in Potočani, continental Croatia (Fig 1). The mass burial is represented by a small pit, approx. 2 m in diameter and about 1 m in depth, containing numerous commingled, in certain cases still articulated, human skeletal remains of 41 individuals of both sexes and a wide range of ages (Fig 2a and 2b). Direct radiocarbon dates (~4200 BCE) as well as several recovered pottery fragments, assign the massacred people to the Middle Eneolithic (Copper Age) Lasinja culture which was widespread in the region of continental Croatia, northern Bosnia, Slovenia, eastern Austria, and western Hungary [22–25].

A comprehensive bioanthropological analysis of the skeletal remains from Potočani mass burial showed perimortem cranial injuries in 13 individuals (six children, three adult males and four adult females) located mostly on the side or the back of the head. The injuries caused by different weapons in combination with archaeological context and absolute dates point to a single episode of execution [22, 23].

It is generally believed that the Lasinja culture originated on the substrate of the Lengyel culture, although due to the large area it occupied as well as the additional influences, the problem of its genesis has additional complexities [26]. The Lasinja culture belongs to the Copper Age, a period when economic and social changes occurred primarily due to a series of impulses that in some way were “inspired” by the local Neolithic populations [27–30]. One of the possible reasons is the increase in the number of cattle which requires more frequent habitat changes after cattle deplete the pastures around the settlement. The importance of cattle for the Lasinja people is confirmed by zooarchaeological records suggesting that cattle husbandry played a significant, even dominant, role in peoples’ lives [31, 32]. The greater mobility probably also led to better and greater communication between different cultural groups. An important factor influencing all these events is the waning and disappearance of the Vinča culture [30]. The other important characteristic of this period is intensified copper mining and the creation of networks associated with these processes. Although there are only a few copper objects known from Lasinja sites in Croatia the people inhabiting the region during this period were familiar with copper production as they used copper objects from different deposits (carbonate and sulfide ore) [33]. Previous studies of metal objects from different Copper Age cultures and ore samples from deposits show that the circulation of excavated ore and metal followed a complex network [34].

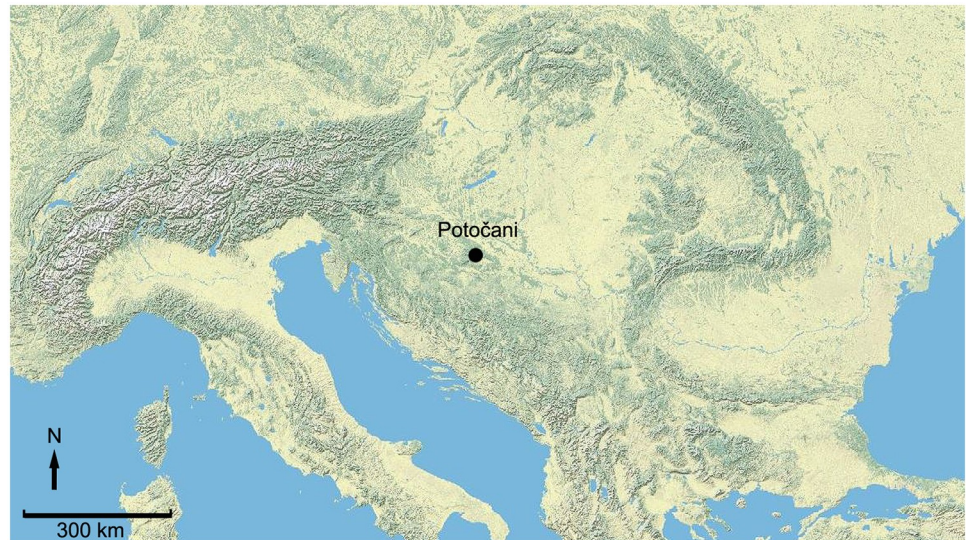

Fig 1. Map showing the geographic location of Potočani (base map credit: USGS National Map Viewer, <http://viewer.nationalmap.gov/viewer/>).

<https://doi.org/10.1371/journal.pone.0247332.g001>

Results and discussion

We generated genome-wide data from almost all individuals retrieved from the Potočani mass burial ($n = 38$). The genotypes have been deposited for public access to the Reich lab website (<https://reich.hms.harvard.edu/datasets>) and the aligned sequences to the EMBL Nucleotide Sequence Database (ENA) with the accession number PRJEB42243. Our analysis of 93% of the individuals shows that the ancestry of the people there was homogeneous. Principal Component Analysis reveals that the analyzed individuals are slightly shifted from the Anatolia Neolithic cluster in the direction of Western European hunter-gatherers, similar to other Middle to Late Neolithic European farmers before the arrival of steppe ancestry, but especially to those from Eastern Europe (Fig 3A). We confirm this pattern by successfully modelling the Potočani individuals as a mixture of predominantly Anatolian Neolithic ancestry with ~9% Western European hunter-gatherer ancestry (Fig 3B), without any evidence of steppe-related ancestry. This is further supported by the presence of paternal lineages typical of Balkan Neolithic populations (G2, I2 and C-V20), and the absence of lineages typical of steppe expansions (R1a and R1b-M269). Overall, our analysis of uniparental markers identifies 30 different mitochondrial lineages and six different Y-chromosome lineages, suggesting that the Potočani victims belonged to a large community with a diverse pool of female lineages.

Next, we studied kinship in the autosomal chromosomes and found that only 11 of the 38 analyzed individuals are closely related (3rd-degree or closer) (Fig 4), belonging to four different pedigrees (Fig 5): (i) I10068 (younger male) with his two daughters I10070 (6-10y old girl) and I10074 (11-17y old girl) and his nephew (son of his brother) I10045 (6-10y old boy), (ii) two infant sisters (I10067 and I10293, 6-10y old girls) with their 3rd-degree relative I10295 (younger male), (iii) a father I10061 (middle-aged male) and his son I10294 (11-17y old boy), and (iv) I10054 (6-10y old boy) with his paternal aunt or half-sister (same father, different mother) I10065 (younger female). Unlike the ~3000 BCE mass grave in Koszyce, Poland representing an extended family connected via several first- and second-degree relationships [13], the Potočani massacre was not targeted to a kinship group: ~70% of the analyzed individuals did not have close kin among the deceased. This suggests a violent attack targeting a small

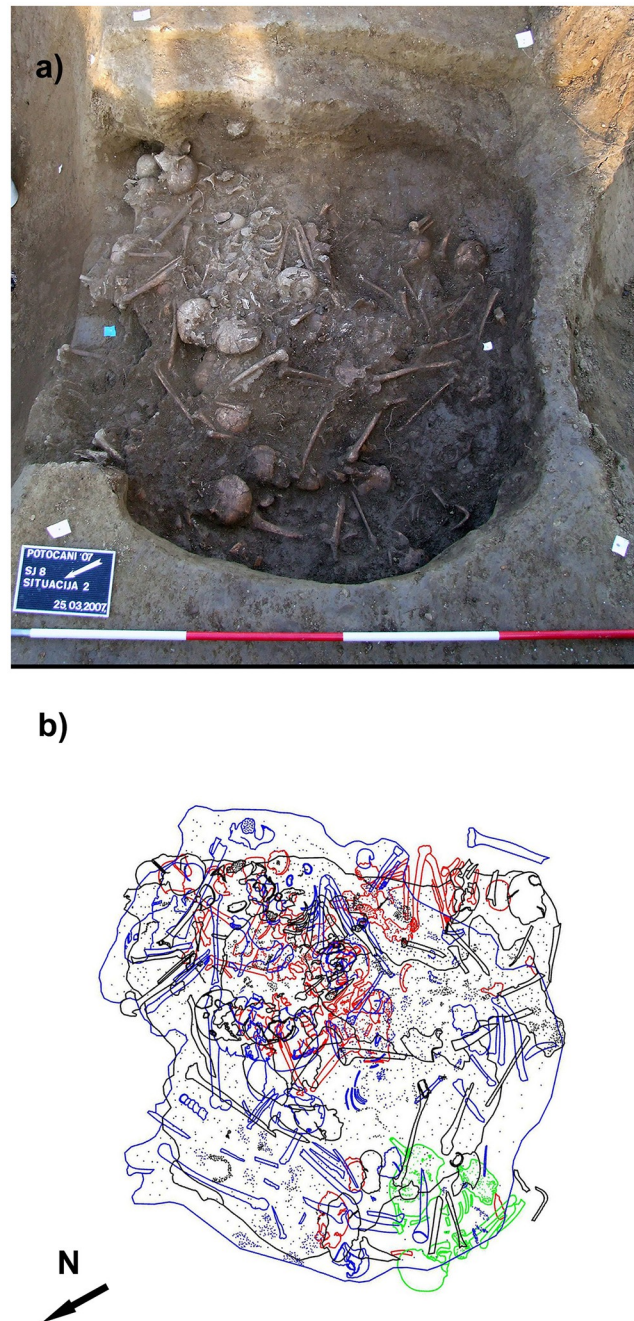

Fig 2. The Potočani mass burial. (A) The upper layers of the pit showing numerous commingled skeletons. (B) Schematics of the middle layer of the pit with different colors marking individual skeletons.

<https://doi.org/10.1371/journal.pone.0247332.g002>

subset of individuals in a community composed of many family groups, instead of targeted killing of a small set of families within the community. The genetic analysis reveals no sex bias (20 assigned females, 18 males), showing that the massacre was also not the outcome of inter-male fighting one would expect in battles [14], and also not the result of a reprisal event targeting individuals of a specific sex.

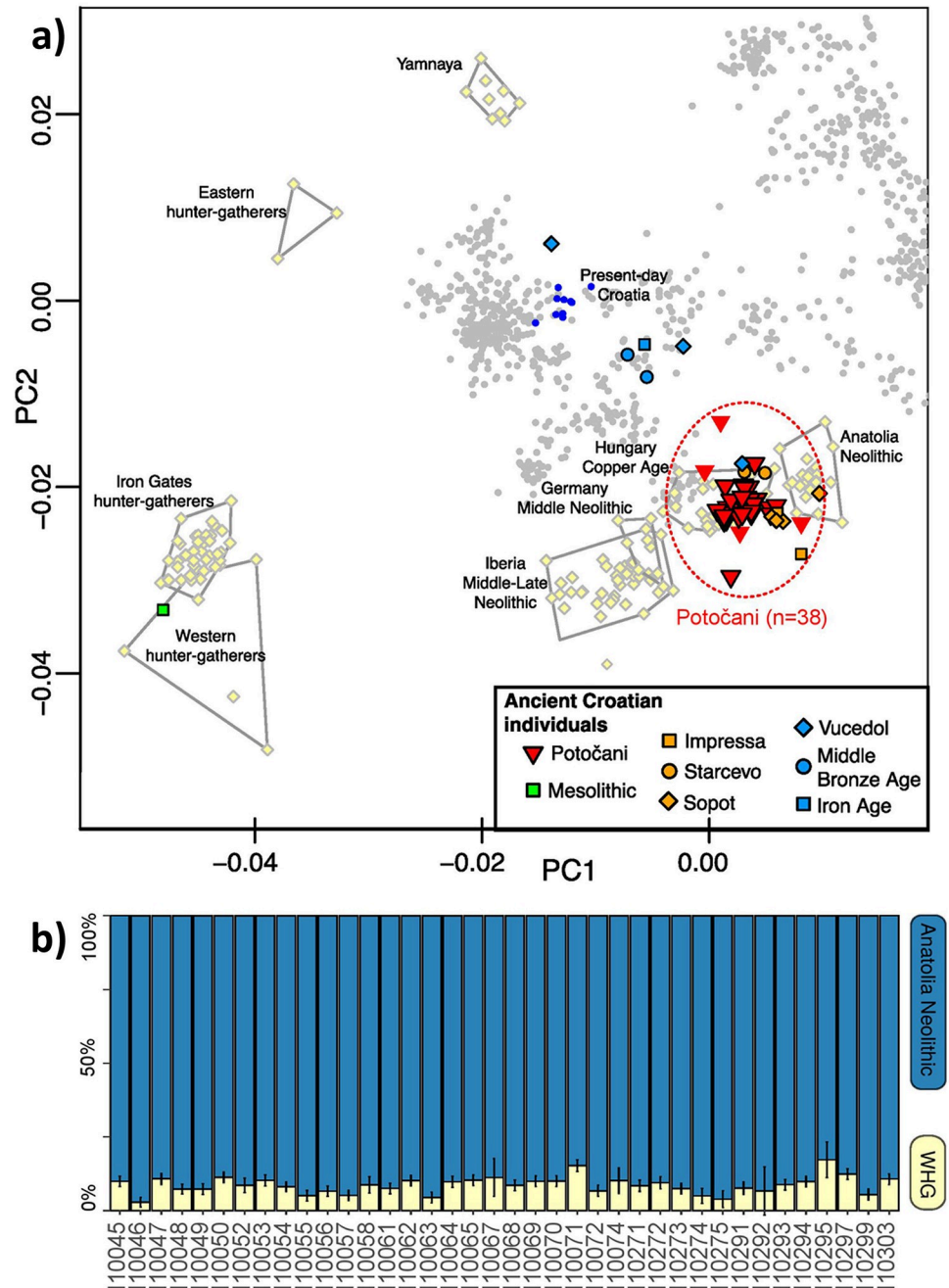

Fig 3. Principal Component Analysis of the Potočani individuals and mixture proportions computed with qpAdm. (A) Present-day West Eurasian individuals from the Human Origin dataset (small dots) were used to compute the principal components, with ancient individuals projected onto those coordinates. Potočani individuals with fewer than 50,000 recovered SNPs are displayed without black outline. (B) The model Anatolia Neolithic + Western hunter-gatherer was used to fit the ancestry of the Potočani individuals. The outgroup set was: Mota, Morocco Iberomaurusian, Villabruna, El Mirón, Eastern hunter-gatherers, Iran Neolithic, Levant Neolithic, Yamnaya Samara.

<https://doi.org/10.1371/journal.pone.0247332.g003>

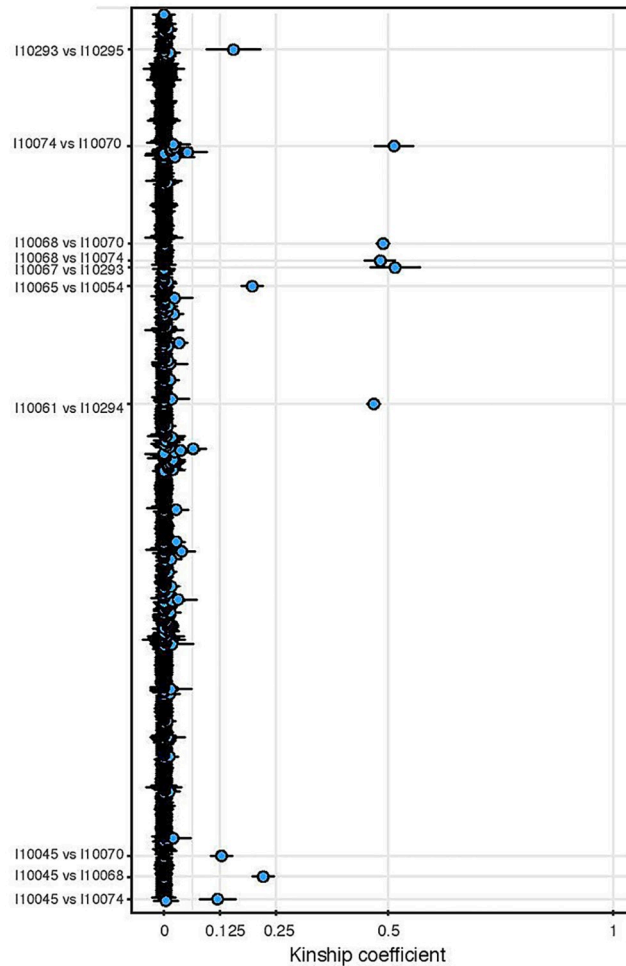

Fig 4. Kinship relationships among the Potočani individuals. We plot the kinship coefficient for each pairwise comparison.

<https://doi.org/10.1371/journal.pone.0247332.g004>

Analysis of runs of homozygosity reveals that the individual's parents were in every case not closely related. Among the 27 ancient individuals with sufficient coverage for this analysis, we detected no close-kin inbreeding on the level of first or second cousins as reflected by the absence of long runs of homozygosity (>20 centimorgan). We found that 21 of the 27 individuals even had no runs of homozygosity longer than 4 cM (Fig 6); such low background relatedness points to a large local population size persisting over dozens of generations. Using the rates of runs of homozygosity 4–20 cM long and assuming a panmictic ancestry pool and a constant-sized population over the last dozens of generations, we estimate the recent effective genetic population size to 20,100–75,600 (95% CI), within the range of estimates typical for Western Eurasian populations after the transition to agriculture [35].

The mass burial from Potočani is a result of indiscriminate killing of an unrelated subset of a population with no sex and age bias, rather than a battle between two armed forces. This hypothesis is based on the demographic composition of the Potočani assemblage that includes both sexes and various age groups completely differing from the distribution seen in battle-related assemblages where younger/middle-aged males are predominant [36–41]. In terms of demographic distributions it is obvious that the Potočani assemblage is almost identical to

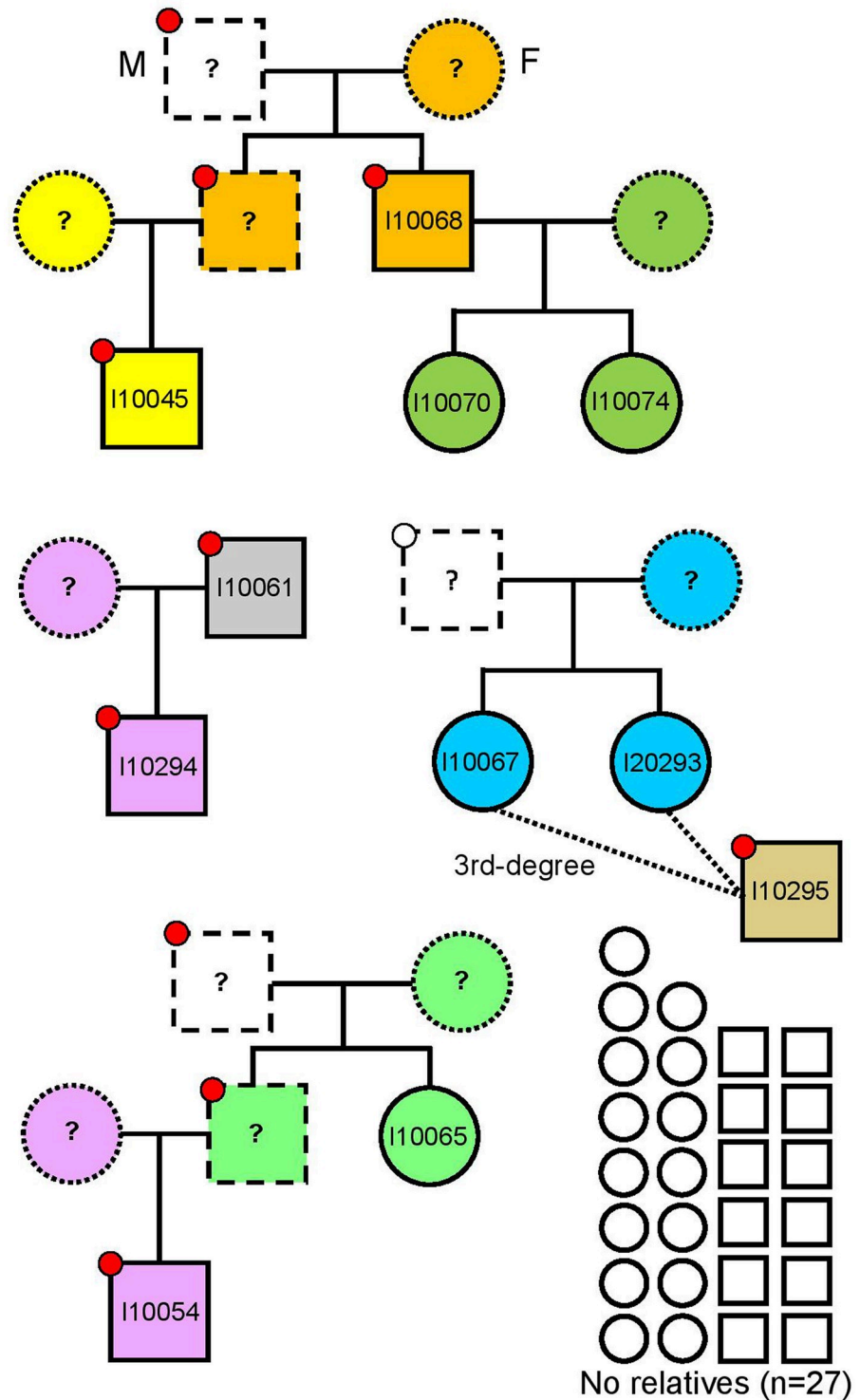

Fig 5. Pedigrees showing the kinship relationships among the Potočani individuals. Circles and squares represent females and males, respectively. Different mitochondrial lineages are represented by different colors inside circles and squares, and different Y-chromosome lineages are represented by different colors inside circles on the upper left corner in males. Empty circles and squares represent individuals who are not closely related (3rd-degree or closer).

<https://doi.org/10.1371/journal.pone.0247332.g005>

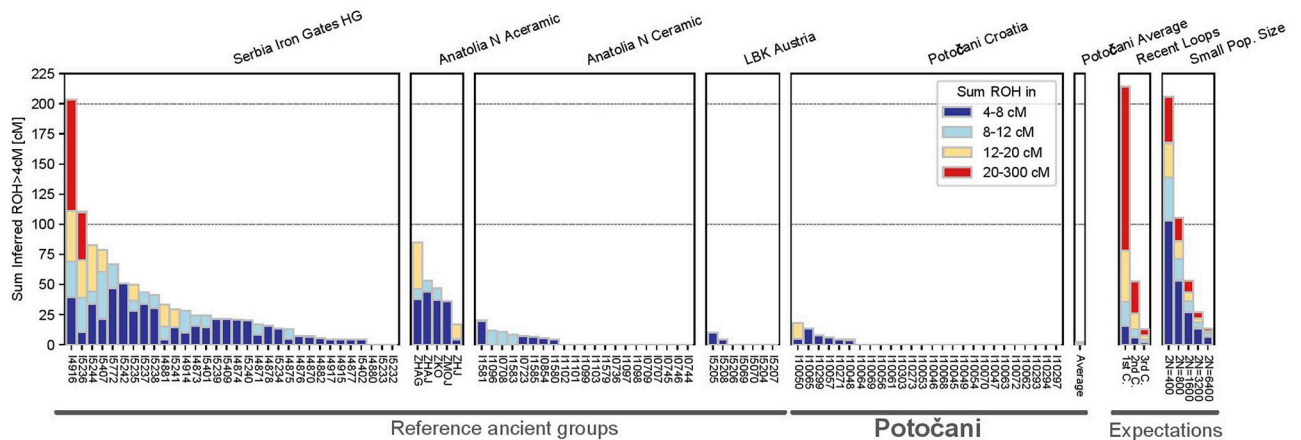

Fig 6. Individual ROH in Potočani individuals and reference populations. We plot ROH for each individual, summing all ROH in four length categories (stacked, colored bars). Individuals with the same population label are grouped into boxes. On the right, we depict a legend with expected ROH for (i) offspring of close kin in an outbred population (“recent loops”) and (ii) panmictic populations, using the values of Ringbauer and colleagues [35].

<https://doi.org/10.1371/journal.pone.0247332.g006>

other prehistoric massacres like Talheim [7], Asparn/Schletz [8], Schöneck-Kilianstädten [11] and Koszyce [13], but also to more recent examples [42–44] where whole or parts of communities were wiped out. The reasons for the upsurge of mass violence as well as the occurrence of massacres during the Neolithic (and Eneolithic) in Europe are “complex and multifactorial” [11]. Nevertheless, the combination of adverse climatic conditions and significant increase in population size is usually provided as the most probable reason for this phenomenon [8, 12, 45].

The examples of modern massacres show that massacres are usually processes (and not singular events) with certain patterns of violence that unfold over time and are manifested in a variety of ways [46]. In this context it is crucial to understand the events and actions leading up to and after massacres as these contribute to the emotional conditions necessary for a massacre [46]. According to some authors [e.g. 20] massacres are characterized by a mental complex which involves debasing and destroying the victims usually viewed by the perpetrators as “others”; only after this process is finished the victims are killed [20]. In other words, leaders blame a certain group for the suffering and hardships present in the society as a whole while suggesting that the situation will improve after the group is eliminated [20]. Channeling community anxiety into fear of the targeted group results in hatred for the group, the “others”, with hatred finally transforming into a desire to eliminate the feared “others”. An additional important aspect that may contribute to the massacre of innocent noncombatants is the process of identity construction and dehumanization of the “others” where they are perceived as a threat and leading to the idea that they must be destroyed in order to save society [20].

Our study is the largest-scale genetic analysis of an ancient massacre to date, and provides insight into a modality of organized violence prior to the rise of large-scale societies [8, 9, 11–13]. We find no sign of population turnover around the time of the massacre, contrasting with the pattern at massacres in the Early Neolithic Pyrenees [9] or in the Globular Amphora culture [13] where the arrival of new people likely played an important role. There is also no evidence of a sex-bias in the massacre, or age-bias or targeting of specific families, as might be expected by a reprisal and or a punitive killing. Instead, the data reveal how organized violence in this period could be indiscriminate just as indiscriminate killings have been an important

feature of life in historic and modern times. An important direction for work will be to study additional massacre sites to determine the prevalence of this pattern of ancient violence.

Materials and methods

(Bio)archaeological context

The permissions for the archaeological fieldwork and the scientific analyses of the human skeletal remains were issued by the Conservation Department of the Ministry of Culture of the Republic of Croatia in Požega. The studied mass burial site is located in the village of Potočani in eastern Croatia; coordinates 45°38'28"N 17°23'27"E. This is the only archaeological feature found at the site as no adjoining settlement was discovered [47]. Radiocarbon dates from three human bones, taken at various horizontal positions in the pit gave near identical results of around 4200 years cal BCE (Beta-233122: 5240±40 BP; Beta-233123: 5310±40 BP; UCIAMS-140250: 5325±20 BP [25]. These dates, as well as several pottery fragments found within the pit, chronologically assign the burial to the Lasinja culture of the Middle Eneolithic (Copper Age).

The Potočani sample consists of a minimum of 41 individuals of both sexes and various age groups. In total, the Potočani population consists of 21 males and 20 females (determined genetically and confirmed morphologically). Over half of the sample (21) consisted of sub-adults: two younger children aged between 2 and 5 years, nine older children aged between 6 and 10 years, and ten adolescents aged between 11 and 17 years. There are 20 adults in total: 14 younger adults aged between 18 and 35 years, five middle-aged adults between 36 and 50 years old, and one adult individual whose age-at-death could not be established with certainty. The paleopathological analysis revealed low prevalence of antemortem tooth loss and carious lesions, the presence of indicators of subadult physiological stress such as cribra orbitalia (20 cases) and linear enamel hypoplasia (six cases), one case of meningitis, scurvy (five cases), and four antemortem well-healed cranial injuries recorded in three adult males and in one sub-adult. Numerous perimortem injuries were noted on at least 13 skulls. These exhibit a total of 28 perimortem injuries, ranging from the most frequent injury of blunt force trauma, stabbing and piercing wounds, and cuts (S1–S3 Figs). There are no visible perimortem injuries on the postcranial part of the analyzed skeletons. The number of recorded trauma per cranium varies between one and four. The distribution of observable cranial injuries does not follow a specific pattern of age and sex—the injuries were observed in one boy aged between 2 and 5 years, one girl aged between 6 and 10 years, three boys and one girl aged between 11 and 17 years, five younger adults (18–35 years; one male and four females) and two middle-aged males (36–50 years). Most of the injuries are located on the lateral, posterior, and/or superior parts of the crania [22, 23]. Nitrogen and carbon stable isotopes analysis indicates that the Potočani people are more enriched in $\delta^{13}\text{C}$ and $\delta^{15}\text{N}$ stable isotopes in comparison to other contemporaneous groups from continental Croatia, suggesting that they were generally consuming more animal products than their neighbors [25].

Ancient DNA data generation

We generated ancient DNA data using a standard set of protocols [48, 49]. We isolated the cochlear portions of petrous bones and generated bone powder by sampling human petrous bones from the cranial base [50]. In dedicated clean rooms, we extracted DNA [51, 52], and generated 1–2 partially UDG-treated double-stranded libraries per sample which we distinguished from each other by using a pair of 7 base pair barcodes affixed to the ends of the ancient molecules [53]. We enriched the libraries on 96-well plates for sequences overlapping the mitochondrial genome [54] or about 1.24 million single nucleotide polymorphisms [55], and sequenced on Illumina NextSeq 500 instruments. We processed the data as previously

described [48], and merged data from libraries consistent with being from the same individual. We tested for evidence of contamination based on four criteria. First we required a rate of damage in the final nucleotide of at least 3% as expected for genuine ancient DNA [53]. Second, we required a rate of match of mitochondrial sequences to the consensus sequence to have an upper bound of its 95% confidence interval of >98% [56]; three individuals did not meet this criterion (I10067, I10074, I10058) but all had low coverage in their mitochondrial DNA sequences (13-fold coverage), and had very low mismatch rates at haplotype-defining mutations covered at least twice and so we do not believe that they have evidence of mitochondrial contamination (S1 File). We also assessed the rate of polymorphism on the X chromosome (only possible in males with a minimum of 200 analyzed X chromosome positions covered at least twice) and determined that all had lower bounds for their 95% confidence intervals of <1% [57]. Fourth, we required that the ratio of Y chromosome sequences to the sum of X and Y chromosome sequences was in the range expected for this type of data for males (>35%) or females (<3%), and confirm that this was the case for all analyzed samples.

Inferring runs of homozygosity (ROH)

We applied the software *hapROH* (downloaded from <https://pypi.org/project/hapROH/>, version 0.1a6) [35] to screen the ancient individuals for ROH. We used default parameters of *hapROH*, which are tuned to work well on 1240K SNPs and using pseudo-haploid eigenstrat file as input. As recommended, we only analyze individuals with data for at least 400,000 SNPs covered. We report the total sum of ROH >4, >8, >12, >20 centimorgan (S1 File), using the default genetic map of *hapROH*, and 5008 global haplotypes from 1000 Genomes as reference. To estimate the genetic effective population size under a panmictic model, we used the maximum likelihood method described and tested in Fernandes and colleagues [58]. Confidence intervals were obtained via the likelihood profile (1.92 units down from the maximum of the log-likelihood function provide a 95% CI).

Inferring kinship

We looked for possible kinship relationships among the Potočani individuals using the same approach as in Olalde and colleagues [59]. In short, we computed pairwise mismatch rates by randomly sampling one allele for each individual at each 1240k SNP position. We then estimated relatedness coefficients r :

$$r = 1 - ((x - b)/b)$$

with x being the mismatch rate for a given pair of individuals and b the mismatch rate expected for two unrelated individuals from the same population, divided by 2. We estimated the mismatch rate expected for two unrelated individuals by computing the median value of all the pairwise mismatch rates between Potočani individuals with more than 100,000 SNPs, assuming that most pairs are not closely related.

Supporting information

S1 Fig. Perimortem cranial trauma in two individuals from Potočani. (A) Oval-shaped blunt force trauma on the right parietal bone of individual I10050 (young adult female); the blow did not penetrate the skull. (B) Oval-shaped blunt force trauma on the right parietal bone of individual I10050 (young adult female); the blow did penetrate the skull. (C) Puncture wound on the frontal bone of individual I10052 (young adult female). (TIF)

S2 Fig. Perimortem cranial trauma in two individuals from Potočani. (A) Round-shaped blunt force trauma on the left parietal bone of individual I10049 (11–17 years old boy); the blow did penetrate the skull. (B) Oval-shaped blunt force trauma on the occipital bone of individual I10056 (young adult female); the blow did penetrate the skull.
(TIF)

S3 Fig. Perimortem cranial trauma in individual I10056 (younger female) from Potočani. Three round-shaped penetrating injuries located one above other on the right parietal and the occipital bones; the blows did penetrate the skull.
(TIF)

S1 File. Extraction, library preparation and sequencing statistics of the new individuals included in the study.
(XLSX)

Acknowledgments

We thank Ana Solter from the Archaeological Museum in Zagreb for providing [Fig 2B](#).

Author Contributions

Conceptualization: Mario Novak, Ron Pinhasi, David Reich.

Data curation: Mario Novak, Jacqueline Balen, Ron Pinhasi, David Reich.

Formal analysis: Iñigo Olalde, Harald Ringbauer.

Funding acquisition: Mario Novak, Iñigo Olalde, Ron Pinhasi, David Reich.

Investigation: Mario Novak, Iñigo Olalde, Harald Ringbauer, Nadin Rohland, James Ahern, Jacqueline Balen, Ivor Janković, Hrvoje Potrebica.

Methodology: Mario Novak, Iñigo Olalde, Harald Ringbauer, Ron Pinhasi, David Reich.

Project administration: Mario Novak, Ron Pinhasi, David Reich.

Resources: Jacqueline Balen, Hrvoje Potrebica.

Software: Iñigo Olalde, Harald Ringbauer.

Supervision: Ron Pinhasi, David Reich.

Validation: Mario Novak, Iñigo Olalde, Harald Ringbauer, Ron Pinhasi, David Reich.

Visualization: Iñigo Olalde, Harald Ringbauer.

Writing – original draft: Mario Novak, Iñigo Olalde, Harald Ringbauer, Ron Pinhasi, David Reich.

Writing – review & editing: Mario Novak, Iñigo Olalde, Harald Ringbauer, Nadin Rohland, James Ahern, Jacqueline Balen, Ivor Janković, Hrvoje Potrebica, Ron Pinhasi, David Reich.

References

1. Anderson J. Late Paleolithic skeletal remains from Nubia. In: Wendorf F, editor. *The prehistory of Nubia, Volume 2*. Dallas: Southern Methodist University Press; 1968. pp. 996–1040.
2. Judd M. Jebel Sahaba revisited. In: Kroeper K, Chlodnicki M, Kobusiewicz M, editors. *Archaeology of early northeastern Africa*. Poznan: Poznan Archaeological Museum. 2007; pp. 153–166.
3. Antoine D, Zazzo A, Friedman R. Revisiting Jebel Sahaba: New apatite radiocarbon dates for one of the Nile Valley's earliest cemeteries. *Am J Phys Anthropol*. 2013; 150 (S56): 68.

4. Antoine D, Ambers J. The scientific analysis of human remains from the British Museum collection: Research potential and examples from the Nile Valley. In: Fletcher A, Antoine D, Hill JD, editors. *Regarding the dead: Human remains in the British Museum*. London: British Museum Press; 2014. pp. 20–30.
5. Mirazón Lahr M, Rivera F, Power RK, Mounier A, Copsey B, Crivellaro F, et al. Inter-group violence among early Holocene hunter-gatherers of West Turkana, Kenya. *Nature*. 2016; 529: 394–398. <https://doi.org/10.1038/nature16477> PMID: 26791728
6. Stojanowski CM, Seidel AC, Fulginiti LC, Johnson KM, Buikstra JE. Contesting the massacre at Nataruk. *Nature*. 2016; 539: E8–E10. <https://doi.org/10.1038/nature19778> PMID: 27882979
7. Wahl J, Trautmann I. The Neolithic massacre at Talheim: A pivotal find in conflict archaeology. In: Schulting R, Fibiger L, editors. *Sticks, stones, and broken bones: Neolithic violence in a European perspective*. Oxford: Oxford University Press; 2012. pp. 77–100.
8. Teschler-Nicola M, Gerold F, Bujatti-Narbeshuber M, Prohaska T, Latkoczy C, Stinger G, et al. Evidence of genocide 7000 BP—Neolithic paradigm and geoclimatic reality. *Coll Antropol*. 1999; 23: 437–450. PMID: 10646219
9. Alt KW, Tejedor Rodríguez C, Nicklisch N, Roth D, Szécsényi Nagy A, Knipper C, et al. A massacre of early Neolithic farmers in the high Pyrenees at Els Trocs, Spain. *Sci Rep*. 2020; 10: 2131. <https://doi.org/10.1038/s41598-020-58483-9> PMID: 32034181
10. Meyer C, Brandt G, Haak W, Ganslmeier RA, Meller H, Alt KW. The Eulau eulogy: Bioarchaeological interpretation of lethal violence in Corded Ware multiple burials from Saxony-Anhalt, Germany. *J Anthropol Archaeol*. 2009; 28: 412–423.
11. Meyer C, Lohr C, Gronenborn D, Alt KW. The massacre mass grave of Schöneck-Kilianstädten reveals new insights into collective violence in Early Neolithic Central Europe. *Proc Natl Acad Sci USA*. 2015; 112: 11217–11222. <https://doi.org/10.1073/pnas.1504365112> PMID: 26283359
12. Meyer C, Knipper C, Nicklisch N, Münster A, Kürbis O, Dresely V, et al. Early Neolithic executions indicated by clustered cranial trauma in the mass grave of Halberstadt. *Nat Commun*. 2018; 9: 2472. <https://doi.org/10.1038/s41467-018-04773-w> PMID: 29941965
13. Schroeder H, Margaryan A, Szmyt M, Theulot B, Włodarczak P, Rasmussen S, et al. Unraveling ancestry, kinship, and violence in a Late Neolithic mass grave. *Proc Natl Acad Sci USA*. 2019; 116: 10705–10710. <https://doi.org/10.1073/pnas.1820210116> PMID: 31061125
14. Burger J, Link V, Blöcher J, Schulz A, Sell C, Pochon Z, et al. Low prevalence of lactase persistence in Bronze Age Europe indicates ongoing strong selection over the last 3,000 years. *Curr Biol*. 2020; 30: 4307–4315.e13. <https://doi.org/10.1016/j.cub.2020.08.033> PMID: 32888485
15. Prieto G, Verano JW, Goepfert N, Kennett D, Quilter J, LeBlanc S, et al. A mass sacrifice of children and camelids at the Huanchaquito-Las Llamas site, Moche Valley, Peru. *PLoS ONE*. 2019; 14(3): e0211691. <https://doi.org/10.1371/journal.pone.0211691> PMID: 30840642
16. Kalyvas SN. Wanton and senseless? The logic of massacres in Algeria. *Ration Soc*. 1999; 11: 243–285.
17. Kuckelman KA, Lightfoot RR, Martin DL. Changing patterns of violence in the Northern San Juan region. *Kiva*. 2000; 66: 147–165.
18. Dutton DG, Boyanowsky EO, Harris Bond M. Extreme mass homicide: From military massacre to genocide. *Aggress Violent Behav*. 2005; 10: 437–473.
19. Verwimp P. Machetes and firearms: The organizations of massacres in Rwanda. *J Peace Res*. 2006; 43: 5–22.
20. Semelin J. *Purify and destroy: The political uses of massacre and genocide*. New York: Columbia University Press; 2009. <https://doi.org/10.7589/0090-3558-45.3.802> PMID: 19617492
21. Alfsdotter C, Papmehl-Dufay L, Victor H. A moment frozen in time: Evidence of a late fifth-century massacre at Sandby borg. *Antiquity*. 2018; 92: 421–436.
22. Janković I, Balen J, Ahern JCM, Premužić Z, Čavka M, Potrebić H, et al. Prehistoric massacre revealed. Perimortem cranial trauma from Potočani, Croatia. *Anthropol Anz*. 2017; 74: 131–141. <https://doi.org/10.1127/anthranz/2017/0688> PMID: 28555241
23. Janković I, Novak M. Bioarchaeology of Copper Age populations in continental Croatia. In: Balen J, Miloglav I, Rajković D, editors. *Back to the past—Copper Age in northern Croatia*. Zagreb / Osijek: Arheološki muzej u Zagrebu / Filozofski fakultet Sveučilišta u Zagrebu / Arheološki muzej Osijek; 2018. pp. 211–223.
24. Čataj L. The Lasinja culture. In: Balen J, Miloglav I, Rajković D, editors. *Back to the past—Copper Age in northern Croatia*. Zagreb / Osijek: Arheološki muzej u Zagrebu / Filozofski fakultet Sveučilišta u Zagrebu / Arheološki muzej Osijek; 2018. pp. 25–47.

25. McClure SB, Zavodny E, Novak M, Balen J, Potreblica H, Janković I, et al. Paleodiet and health in a mass burial population: The stable carbon and nitrogen isotopes from Potočani, a 6200-year-old massacre site in Croatia. *Int J Osteoarchaeol*. 2020; 30: 507–518.
26. Marković Z. Sjeverna Hrvatska od neolita do brončanog doba. Koprivnica: Muzej grada Koprivnice; 1994.
27. Bánffy E. South-west Transdanubia as a mediating area. On the cultural history of the Early and Middle Chalcolithic. *Antaeus*. 1995; 22: 157–196.
28. Whittle AWR. Europe in the Neolithic: The creation of new worlds. Cambridge: Cambridge University Press; 1996.
29. Bailey DW. Balkan prehistory: Exclusion, incorporation and identity. London / New York: Routledge; 2000.
30. Bánffy E. 2002. A unique southeastern vessel type from early chalcolithic Transdanubia: Data on the „western route“. *Acta Archaeol Acad Sci Hungaricae*. 2002; 53: 41–60.
31. Toškan B. Živalski ostalki. In: Velušček A, editor. Spaha. Ljubljana: ZRC SAZU, Institut za arheologiju; 2011. pp. 265–282.
32. Trbojević Vukičević T. Arheozoološka analiza naselja lasinjske kulture. In Kornelija M, Marković Z, editors. *Beketinci—Bentež, naselja iz eneolitika, ranoga i kasnoga srednjega vijeka*. Zagreb: Institut za arheologiju; 2013. pp. 140–144. <https://doi.org/10.1111/ahc.12042> PMID: 23464657
33. Balen J, Zorić J. Metalni nalazi lasinjske kulture s nalazišta Pajtenica—Velike livade. In: Botić K, editor. *Zbornik Instituta za arheologiju u Zagrebu, Volume 15*. Zagreb: Institut za arheologiju; in press.
34. Antonović D. Eneolithic copper mines in the Balkans. In: Balen J, Miloglav I, Rajković D, editors. *Back to the past—Copper Age in northern Croatia*. Zagreb / Osijek: Arheološki muzej u Zagrebu / Filozofski fakultet Sveučilišta u Zagrebu / Arheološki muzej Osijek; 2018. pp. 187–209.
35. Ringbauer H, Novembre J, Steinrücken M. Detecting runs of homozygosity from low-coverage ancient DNA. *Curr Biol*. 2020; 30: R980–R981. <https://doi.org/10.1016/j.cub.2020.07.072> PMID: 32898493
36. Jantzen D, Brinker U, Orschiedt J, Heinemeier J, Piek J, Hauenstein K, et al. A Bronze Age battlefield? Weapons and trauma in the Tollense Valley, north-eastern Germany. *Antiquity*. 2011; 85: 417–433.
37. Viva S, Lonoce N, Vincenti G, Cameriere R, Valentino M, Vassallo S, et al. The mass burials from the western necropolis of the Greek colony of Himera (Sicily) related to the battles of 480 and 409 BCE. *Int J Osteoarchaeol*. 2020; 30: 307–317.
38. Cunha E, Silva AM. War lesions from the famous Portuguese medieval battle of Aljubarrota. *Int J Osteoarchaeol*. 1997; 7: 595–599.
39. Fiorato V, Boylston A, Knüsel C. Blood red roses: The archaeology of a mass grave from the Battle of Towton AD 1461. Oxford: Oxbow; 2007.
40. Nicklisch N, Ramsthaler F, Meller H, Friederich S, Alt KW. The face of war: Trauma analysis of a mass grave from the Battle of Lützen (1632). *PLoS ONE*. 2017; 12: e0178252. <https://doi.org/10.1371/journal.pone.0178252> PMID: 28542491
41. Scott DD, Willey P, Connor MA. They died with Custer: Soldiers' bones from the Battle of the Little Bighorn. Norman: University of Oklahoma Press; 1998.
42. Šlaus M, Novak M, Vyroubal V, Bedić Ž. The harsh life on the 15th century Croatia-Ottoman Empire military border: Analyzing and identifying the reasons for the massacre in Čepin. *Am J Phys Anthropol*. 2010; 141: 358–372. <https://doi.org/10.1002/ajpa.21152> PMID: 19902455
43. Willey P, Emmerson TE. The osteology and archaeology of the Crow Creek massacre. *Plains Anthropol*. 1993; 38: 227–269.
44. De Vore WE, Jacobi KP, Dye DH. Rethinking massacres: A bioarchaeological and forensic investigation of prehistoric multiple burials in the Tennessee River Valley. In: Anderson CP, Martin DL, editors. *Massacres: Bioarchaeology and forensic anthropology approaches*. Gainesville: University Press of Florida; 2018. pp. 12–22. <https://doi.org/10.1021/acs.est.8b02724> PMID: 30412391
45. Gronenborn D, Strien H-C, Dietrich S, Sirocko F. 'Adaptive cycles' and climate fluctuations: A case study from Linear Pottery Culture in western Central Europe. *J Archaeol Sci*. 2014; 51: 73–83.
46. Klusemann S. Massacres as process: A micro-sociological theory of internal patterns of mass atrocities. *Eur J Criminol*. 2012; 9: 468–480.
47. Potreblica H, Balen J. Rekognosciranje južnih obronaka Papuka (zona Velika—Stražeman). *Hrv arh god*. 2008; 4/2007: 116–119.
48. Mathieson I, Lazaridis I, Rohland N, Mallick S, Patterson P, Alpaslan Roodenberg S, et al. Genome-wide patterns of selection in 230 ancient Eurasians. *Nature*. 2015; 528: 499–503. <https://doi.org/10.1038/nature16152> PMID: 26595274

49. Fernandes DM, Mitnik A, Olalde I, Lazaridis I, Cheronet O, Rohland N, et al. The spread of steppe and Iranian-related ancestry in the islands of the western Mediterranean. *Nat Ecol Evol.* 2020; 4: 334–345. <https://doi.org/10.1038/s41559-020-1102-0> PMID: 32094539
50. Sirak KA, Fernandes DM, Cheronet O, Novak M, Gamarra B, Balassa T, et al. A minimally-invasive method for sampling human petrous bones from the cranial base for ancient DNA analysis. *BioTechniques.* 2017; 62: 283–289. <https://doi.org/10.2144/000114558> PMID: 28625158
51. Dabney J, Knapp M, Glocke I, Gansauge M-T, Weihmann A, Nickel B, et al. mtDNA genome from a Middle Pleistocene cave bear. *Proc Natl Acad Sci USA.* 2013; 110: 15758–15763. <https://doi.org/10.1073/pnas.1314445110> PMID: 24019490
52. Korlević P, Gerber T, Gansauge M-T, Hajdinjak M, Nagel S, et al. Reducing microbial and human contamination in DNA extractions from ancient bones and teeth. *BioTechniques.* 2015; 59: 87–93. <https://doi.org/10.2144/000114320> PMID: 26260087
53. Rohland N, Harney E, Mallick S, Nordenfelt S, Reich D. Partial uracil–DNA–glycosylase treatment for screening of ancient DNA. *Phil Trans R Soc B.* 2015; 370: 20130624. <https://doi.org/10.1098/rstb.2013.0624> PMID: 25487342
54. Maricic T, Whitten M, Pääbo S. Multiplexed DNA sequence capture of mitochondrial genomes using PCR products. *PLoS ONE.* 2010; 5(11): e14004. <https://doi.org/10.1371/journal.pone.0014004> PMID: 21103372
55. Fu Q, Hajdinjak M, Moldovan OT, Constantin S, Mallick S, Skoglund P, et al. An early modern human from Romania with a recent Neanderthal ancestor. *Nature.* 2015; 524: 216–219. <https://doi.org/10.1038/nature14558> PMID: 26098372
56. Fu Q, Mitnik A, Johnson PLF, Bos K, Lari M, Bollongino R, et al. A revised timescale for human evolution based on ancient mitochondrial genomes. *Curr Biol.* 2013; 23: 553–559. <https://doi.org/10.1016/j.cub.2013.02.044> PMID: 23523248
57. Korneliusen TS, Albrechtsen A, Nielsen R. ANGSD: Analysis of next generation sequencing data. *BMC Bioinform.* 2014; 15: 356. <https://doi.org/10.1186/s12859-014-0356-4> PMID: 25420514
58. Fernandes DM, Sirak KA, Ringbauer H, Sedig J, Rohland N, Cheronet O, et al. A genetic history of the pre-contact Caribbean. *Nature.* 2021; 590: 103–110. <https://doi.org/10.1038/s41586-020-03053-2> PMID: 33361817
59. Olalde I, Mallick S, Patterson N, Rohland N, Villalba-Mouco V, Silva M, et al. The genomic history of the Iberian Peninsula over the past 8000 years. *Science.* 2019; 363: 1230–1234. <https://doi.org/10.1126/science.aav4040> PMID: 30872528